



CE Ex Group II Category 3G c T3 / 3D c T125°C

TECHNICAL CHARACTERISTICS

- Unit in conformity to :
ATEX 94/9/CE DIRECTIVE
MACHINERY DIRECTIVE 98/37/CE
- Mountable in any plane
- E-motors thermally protected with Klixon
- Complete with metallic screen IP20, both in in/outlets ports

OPTIONS

- Special voltages (IEC 38)
- Surface treatments

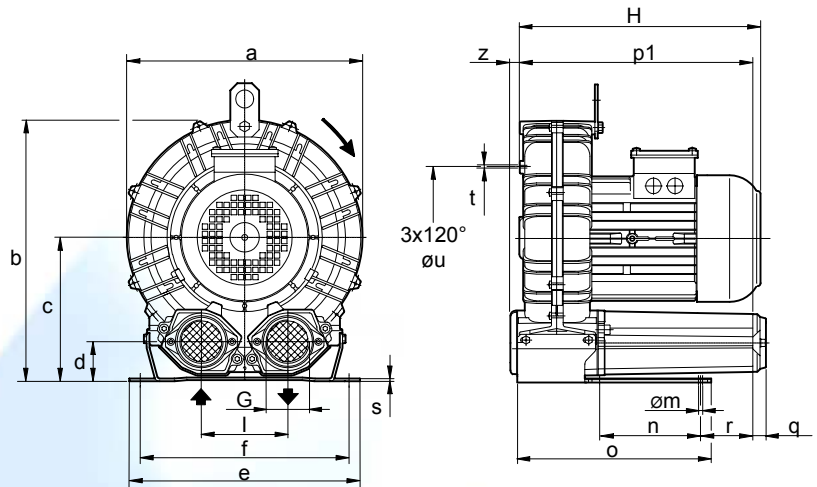

Dimensions in mm.
 Dimensions for reference only.

Model	a	b	c	d	e	f	G	l	m	n	o	p1	q	r	s	t	u	z
K03-MS	241	268	147	43	230	205	G 1" 1/4	86	10	83	142	205	18	75	4	M6	140	12
K04-MS	285	315	172	49	255	225	G 1" 1/2	102	12	95	171	222	18	70	4	M6	175	18
K05-MS	327	365	200	54	320	260	G 2"	120	15	115	265	320	18	98	4	M8	200	19
K06-MS	376	393	205	54	325	290	G 2"	125	15	140	272	334	18	85	4	M8	240	19

Model	Maximum flow m³/h		Installed power kW		Maximum differential pressure Δp hPa (mbar)		Noise level Lp dB (A) (1)		Overall dimensions H mm	Weight Kg
	50 Hz 2900 rpm	60 Hz 3500 rpm	50 Hz 2900 rpm	60 Hz 3500 rpm	50 Hz 2900 rpm	60 Hz 3500 rpm	50 Hz 2900 rpm	60 Hz 3500 rpm		
K03-MS	74	89	0.55	0.66	120	150	59.0	61.0	298	13.0
			0.75	0.86	140	120	61.6	63.6		
K04-MS	137	166	1.1	1.25	200	175	61.8	63.8	311	17.1
			1.5	1.7	160	130	67.5	69.5		
K05-MS	219	265	2.2	2.5	200	225	67.8	69.8	380	28.0
			3.0	3.5	200	175	70.3	72.3		
K06-MS	304	366	4.0	4.6	225	250	70.6	72.6	407	34.5

(1) Noise measured at 1 m distance with inlet and outlet ports piped, in accordance to ISO 3744.

- For proper use, the blower should be equipped with inlet filter and safety valve; other accessories available on request.
- Admissible room temperature and suction temperature from -15°C to +40°C.
- Specifications subject to change without notice.

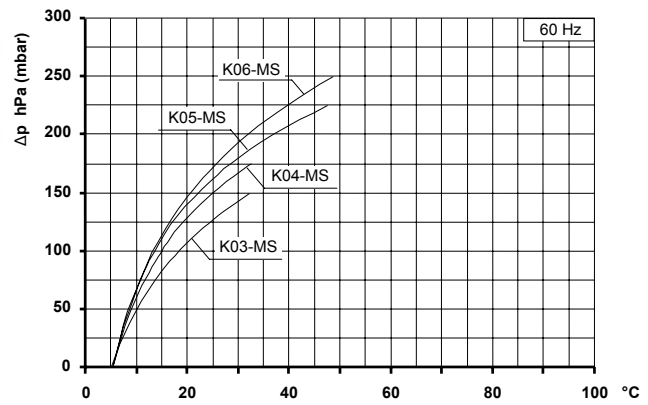
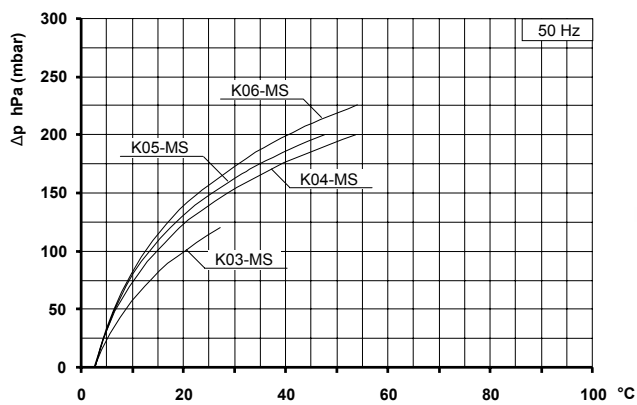
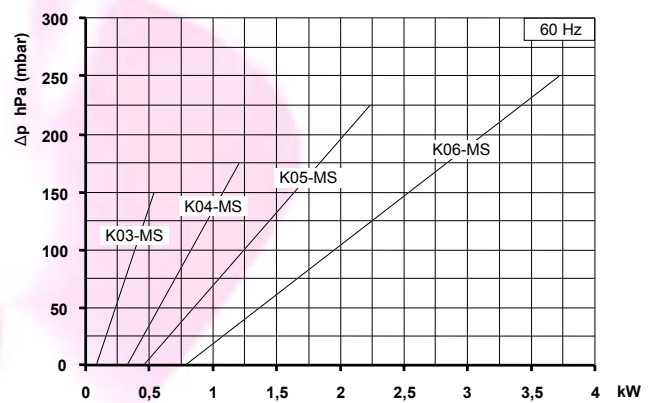
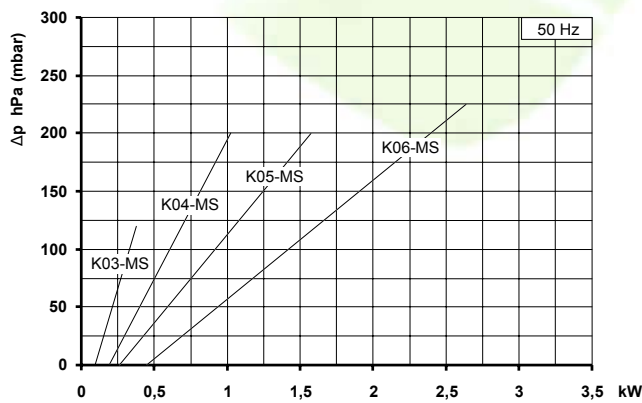
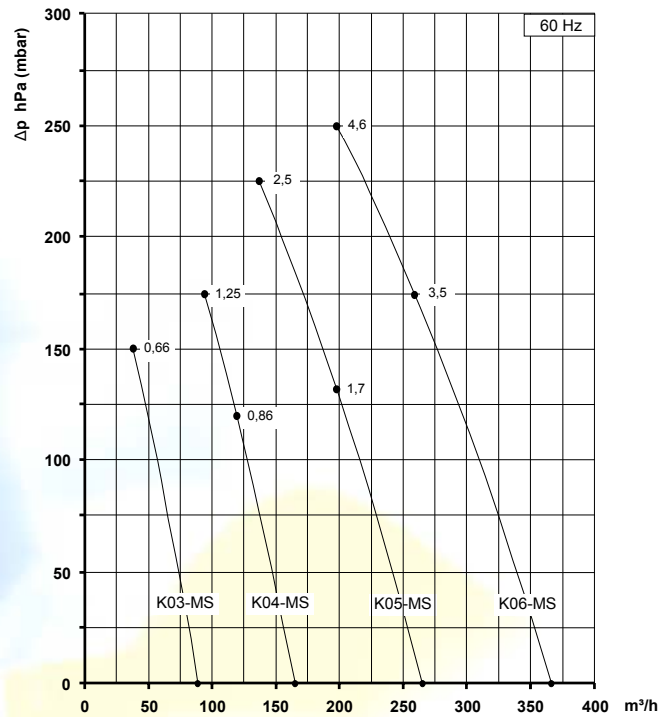
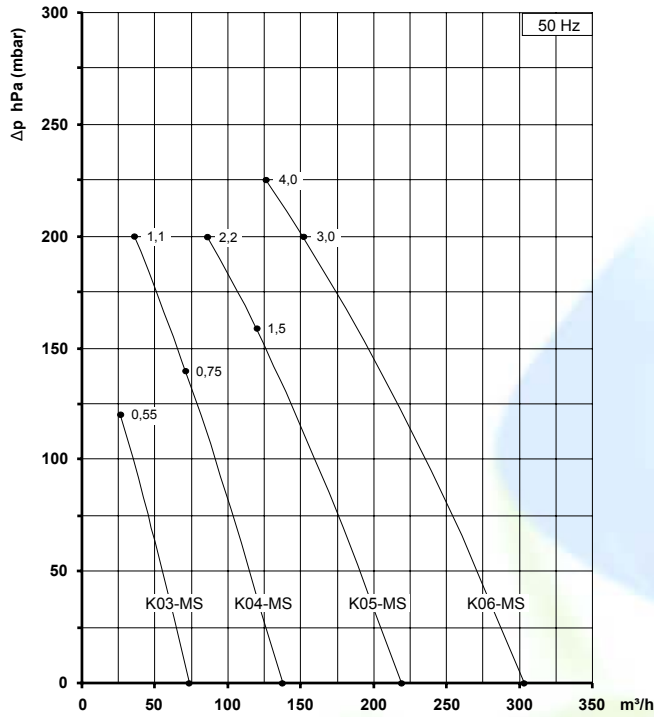

Curves refer to air at 20°C temperature, measured at inlet port and 1013 mbar (abs) atmospheric backpressure. Values for flow, power consumption and temperature rise: +/-10% tolerance. Data can change without prior notice.